



Intellectual
Property
Office

Certificate of Registration for a UK Design

Design number: 6343271

Grant date: 06 February 2024

Registration date: 30 January 2024

This is to certify that,

in pursuance of and subject to the provision of Registered Designs Act 1949, the design of which a representation or specimen is attached, had been registered as of the date of registration shown above in the name of

Amod Shivaji Patil, Paramjeet Kaur, Simran Aggarwal, Shubham Pandey, Dr.

Meenu Beniwal, Manoj Gangadhar Shinde, Shourabh Sadhow, Bindu Singh

Yadav, Dr. Harjeet Singh, Mr. Avinash Kumar Rao

in respect of the application of such design to:

Advanced chemistry analyzer for measuring the concentration of substances in

body fluid

International Design Classification:

Version: 14-2023

Class: 24 MEDICAL AND LABORATORY EQUIPMENT

Subclass: 01 APPARATUS AND EQUIPMENT FOR DOCTORS, HOSPITALS
AND LABORATORIES

Adam Williams

Comptroller-General of Patents, Designs and Trade Marks
Intellectual Property Office

The attention of the Proprietor(s) is drawn to the important notes overleaf.



Representation of Designs

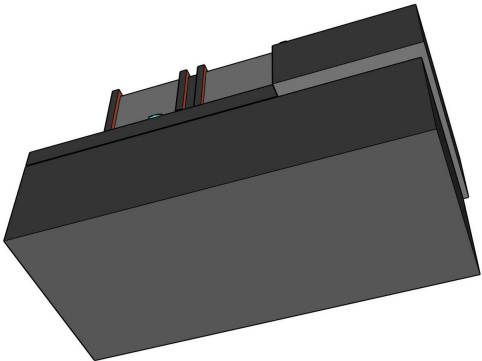
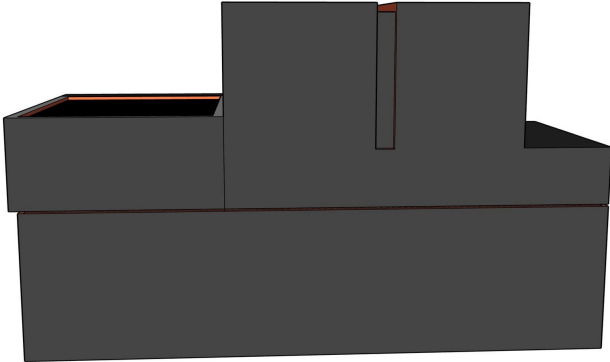

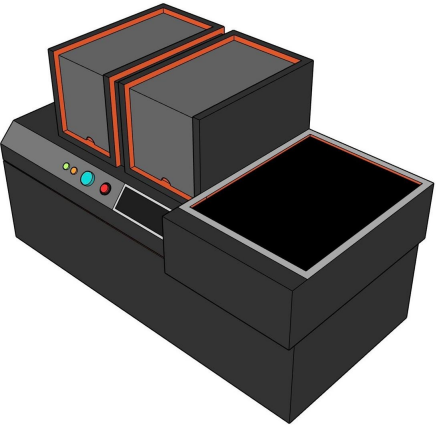
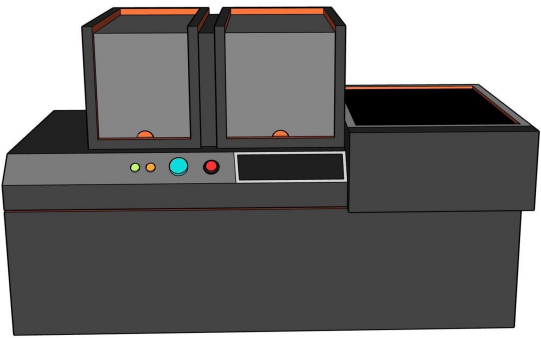

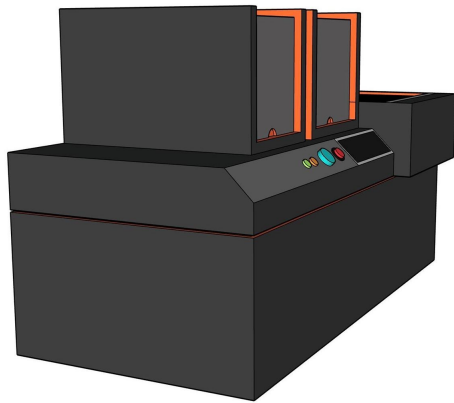
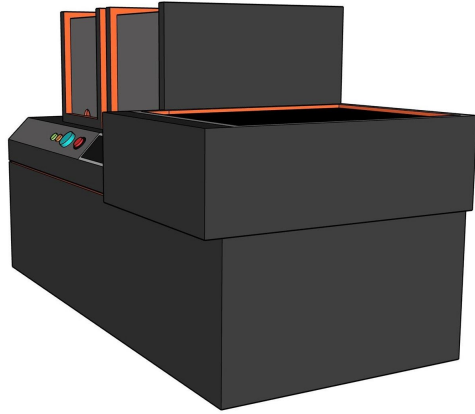

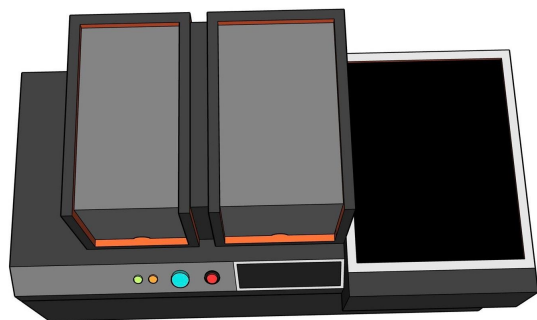

Intellectual Property Office is an operating name of the Patent Office

www.gov.uk/ipo