



Intellectual
Property
Office

Certificate of Registration for a UK Design

Design number: 6327442

Grant date: 27 November 2023

Registration date: 20 November 2023

This is to certify that,

in pursuance of and subject to the provision of Registered Designs Act 1949, the design of which a representation or specimen is attached, had been registered as of the date of registration shown above in the name of

Prof. (Dr.) Nityananda Mondal, Mr. Sanjiban Utpalkumar Sarkar, Ms. Sancharee

Mondal, Mr. Pallab Dasgupta, Mr. Aakash Saha, Mr. Abani Roy, Ms. Pooja

Pradhan, Dr. Preety Choudhary

in respect of the application of such design to:

PORTABLE 3D PRINTER FOR DEVELOPMENT OF NANOFIBRES

International Design Classification:

Version: 14-2023

Class: 15 MACHINES, NOT ELSEWHERE SPECIFIED

Subclass: 09 MACHINE TOOLS, ABRADING AND FOUNDING MACHINERY

Adam Williams

Comptroller-General of Patents, Designs and Trade Marks

Intellectual Property Office

The attention of the Proprietor(s) is drawn to the important notes overleaf.



Representation of Designs

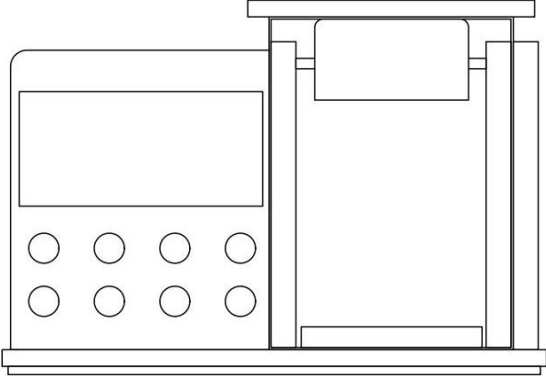
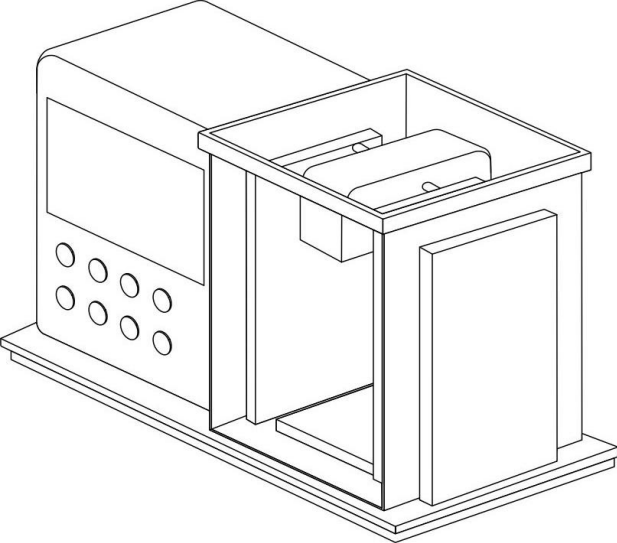

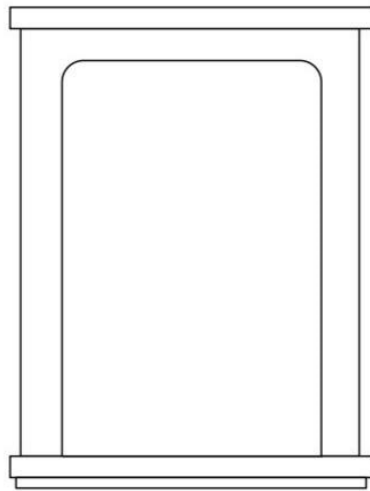
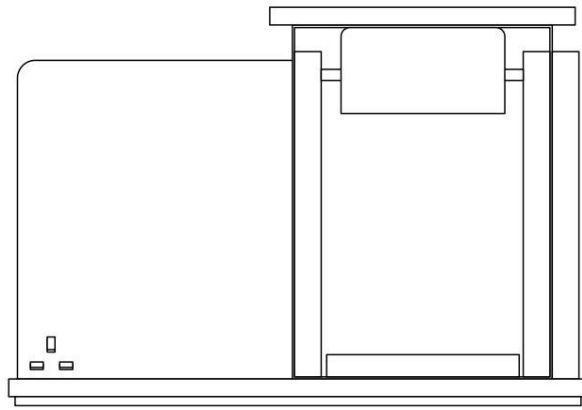

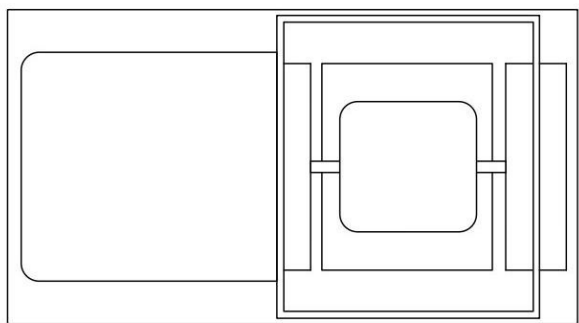
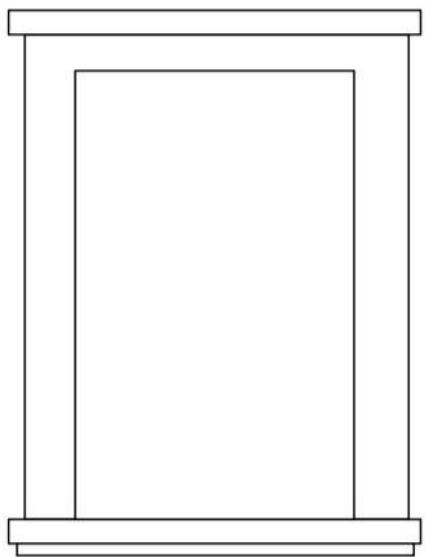

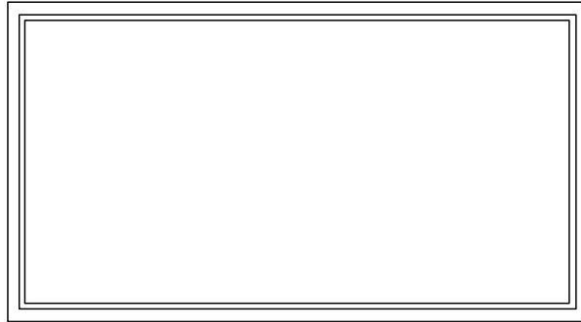

Intellectual Property Office is an operating name of the Patent Office

www.gov.uk/ipo